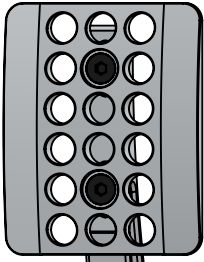
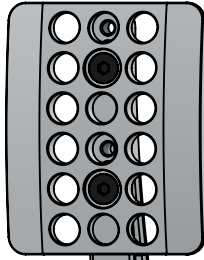
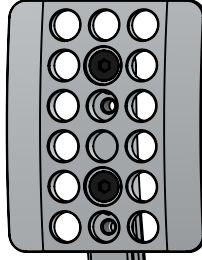
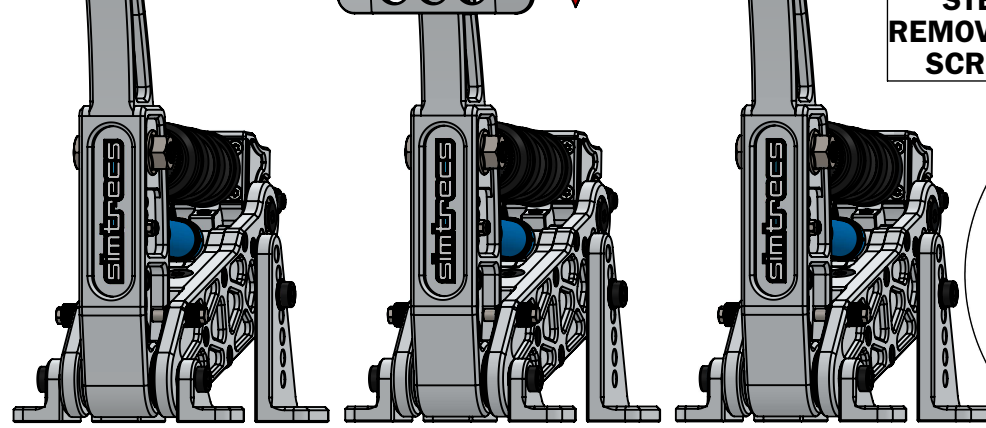
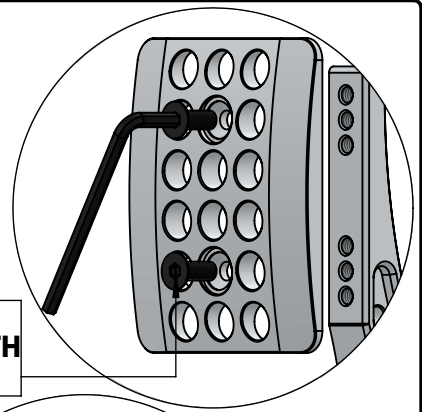
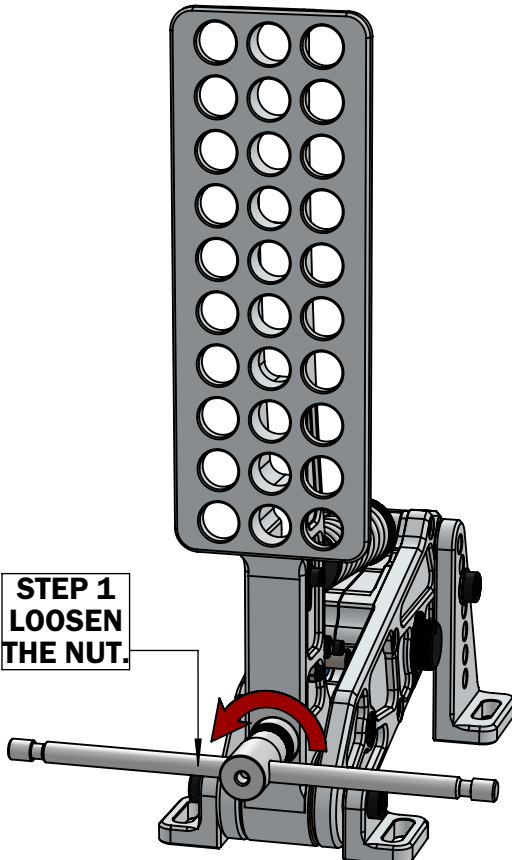
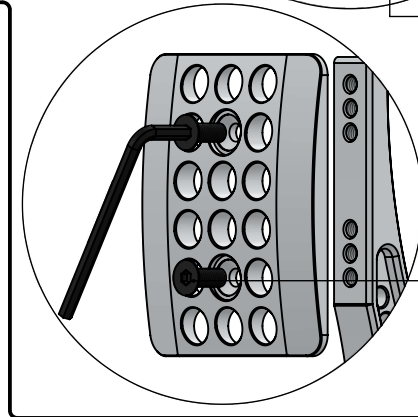
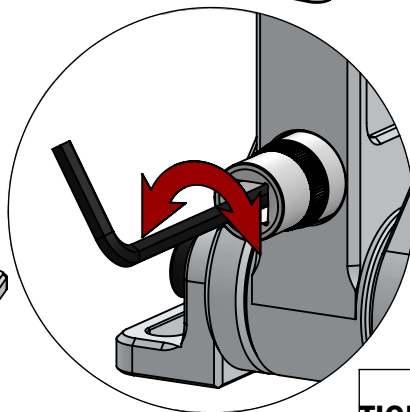

CENTER POSITION**LOWER POSITION****-8mm****UPPER POSITION****+8mm****STEP 1
REMOVE BOTH
SCREWS.**

The adjustment procedure is the the same for brake and clutch pedal as well.

Use 3mm hex wrench and 10mm socket drive for this step.
The pedal travel adjustment procedure is the same for throttle and clutch pedals as well.**STEP 2
TURNING THE SCREW LEFT
WILL INCREASE, AND
TURNING IT TO RIGHT WILL REDUCE
THE PEDAL TRAVEL. DURING THE
PROCESS HOLD WITH ONE HAND
THE 10mm SOCKET DRIVER.****STEP 2
ADJUST THE
PEDAL TO THE
DESIRED
POSITION.****STEP 3
ADD AND
TIGHTEN
BOTH
SCREWS.****STEP 1
LOOSEN
THE NUT.****STEP 3
TIGHTEN THE NUT.**